

CHADSWORTH INCORPORATED

CAST RESIN CAPITALS

5-1/4" ROMAN IONIC

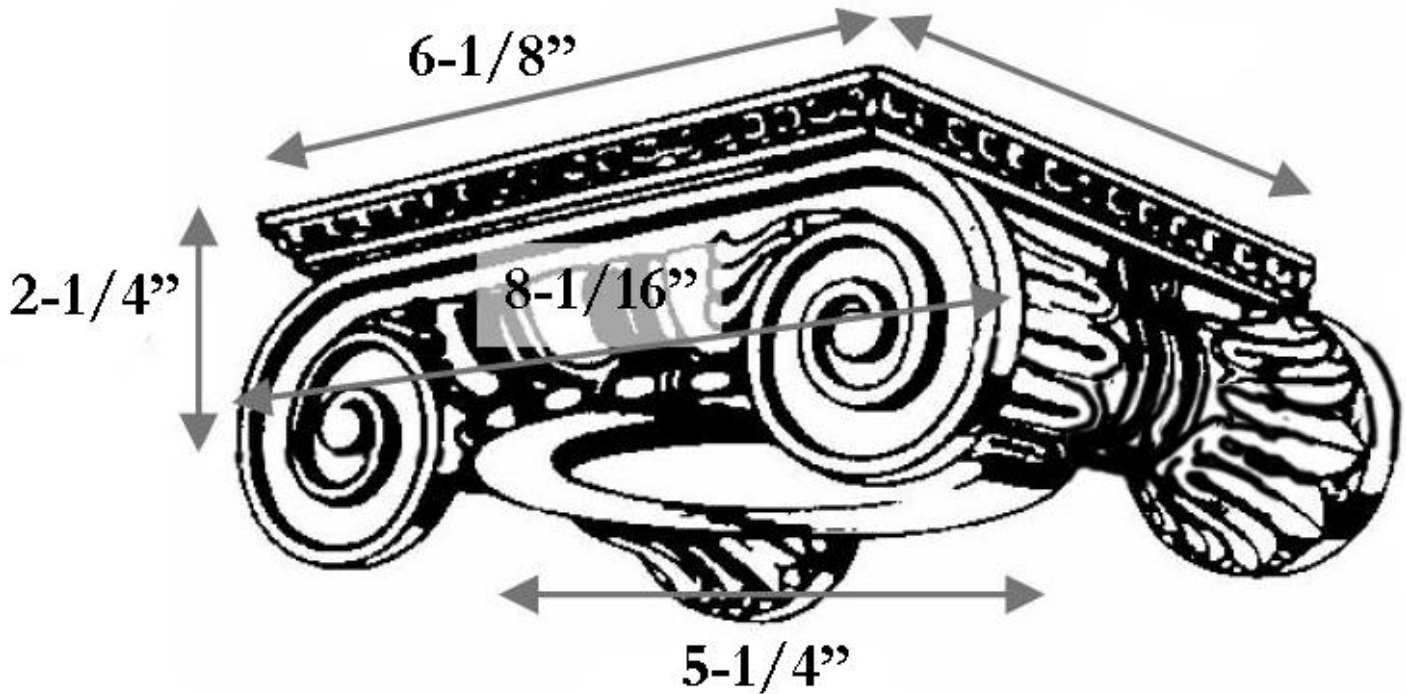

SPECIFICATIONS

Load Bearing:	Yes
Material:	Cast Polyester Resin
Base Width:	5-1/4"
Height:	2-1/4"
Abacus:	6-1/8"
Scroll to Scroll:	8-1/16"