

CHADSWORTH INCORPORATED

CAST RESIN CAPITALS

7-1/2" ROMAN IONIC

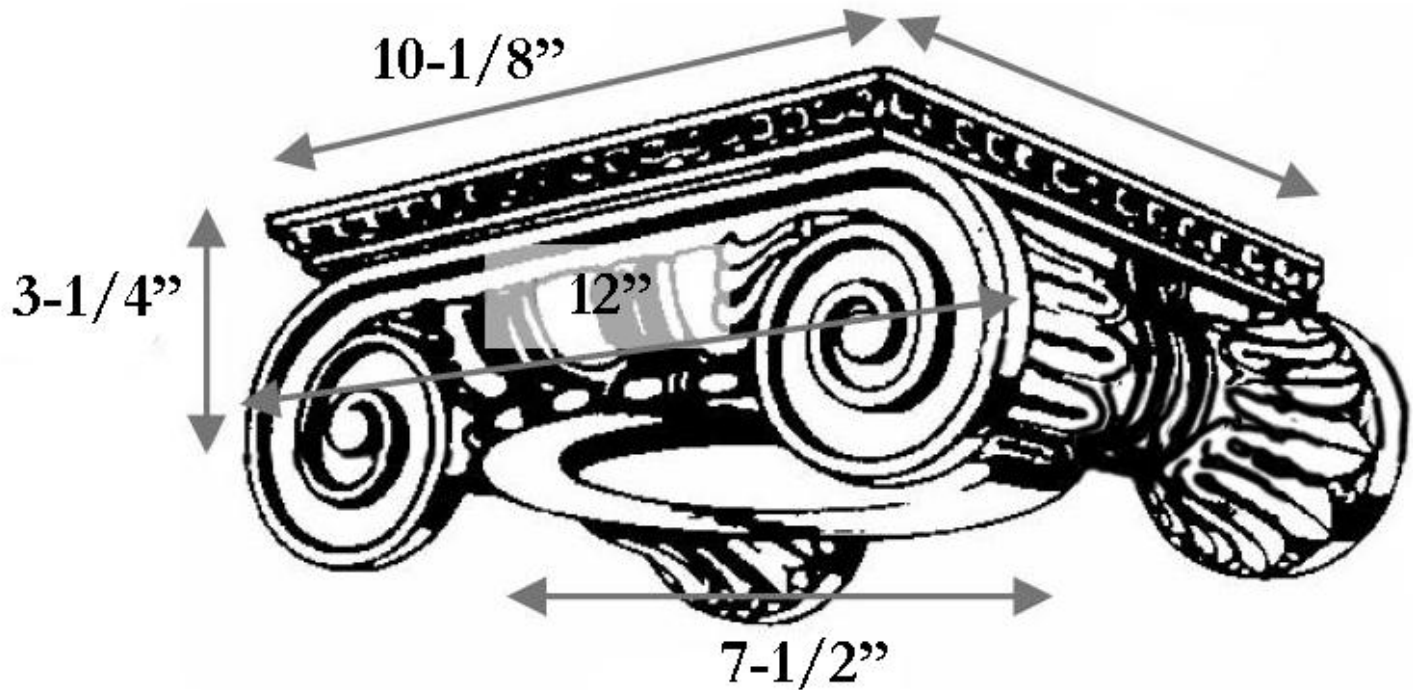

SPECIFICATIONS

Load Bearing:	Yes
Material:	Cast Polyester Resin
Base Width:	7-1/2"
Height:	3-1/4"
Abacus:	10-1/8"
Scroll to Scroll:	12"