

CHADSWORTH INCORPORATED

CAST RESIN CAPITALS

13" SCAMOZZI

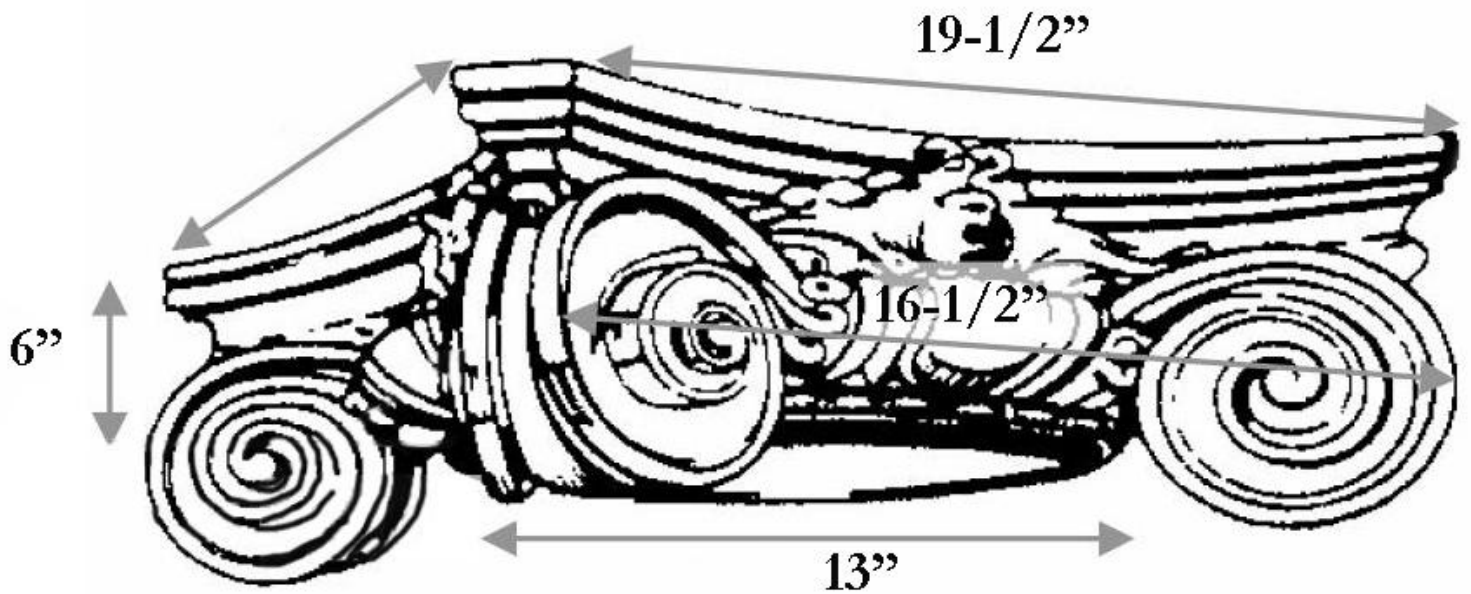

SPECIFICATIONS

Load Bearing:	Yes
Material:	Cast Polyester Resin
Base Width:	13"
Height:	6"
Abacus:	19-1/2"
Scroll to Scroll:	16-1/2"