

CHADSWORTH INCORPORATED

CAST RESIN CAPITALS

4-1/4" SCAMOZZI

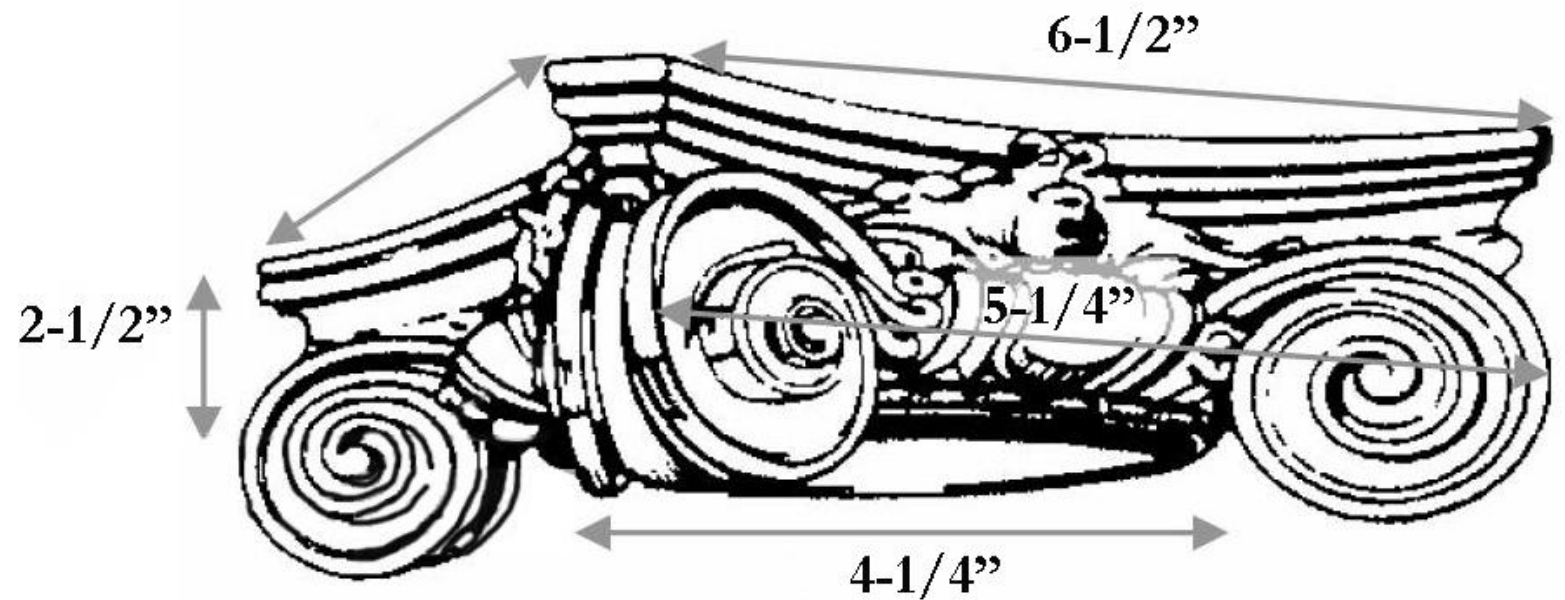

SPECIFICATIONS

Load Bearing:	Yes
Material:	Cast Polyester Resin
Base Width:	4-1/4"
Height:	2-1/2"
Abacus:	6-1/2"
Scroll to Scroll:	5-1/4"