

CHADSWORTH INCORPORATED

CAST RESIN CAPITALS

5-1/4" SCAMOZZI

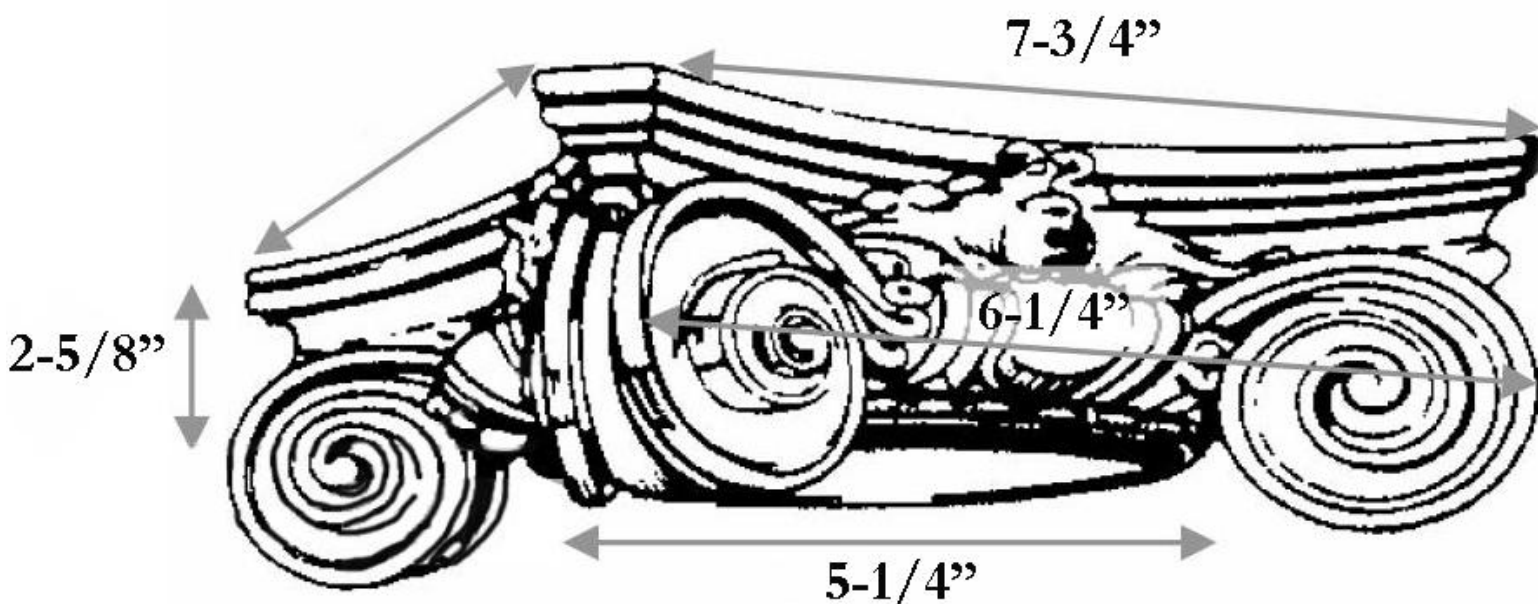

SPECIFICATIONS

Load Bearing:	Yes
Material:	Cast Polyester Resin
Base Width:	5-1/4"
Height:	2-5/8"
Abacus:	7-3/4"
Scroll to Scroll:	6-1/4"