

CHADSWORTH INCORPORATED

CAST RESIN CAPITALS

5-1/2" SCAMOZZI

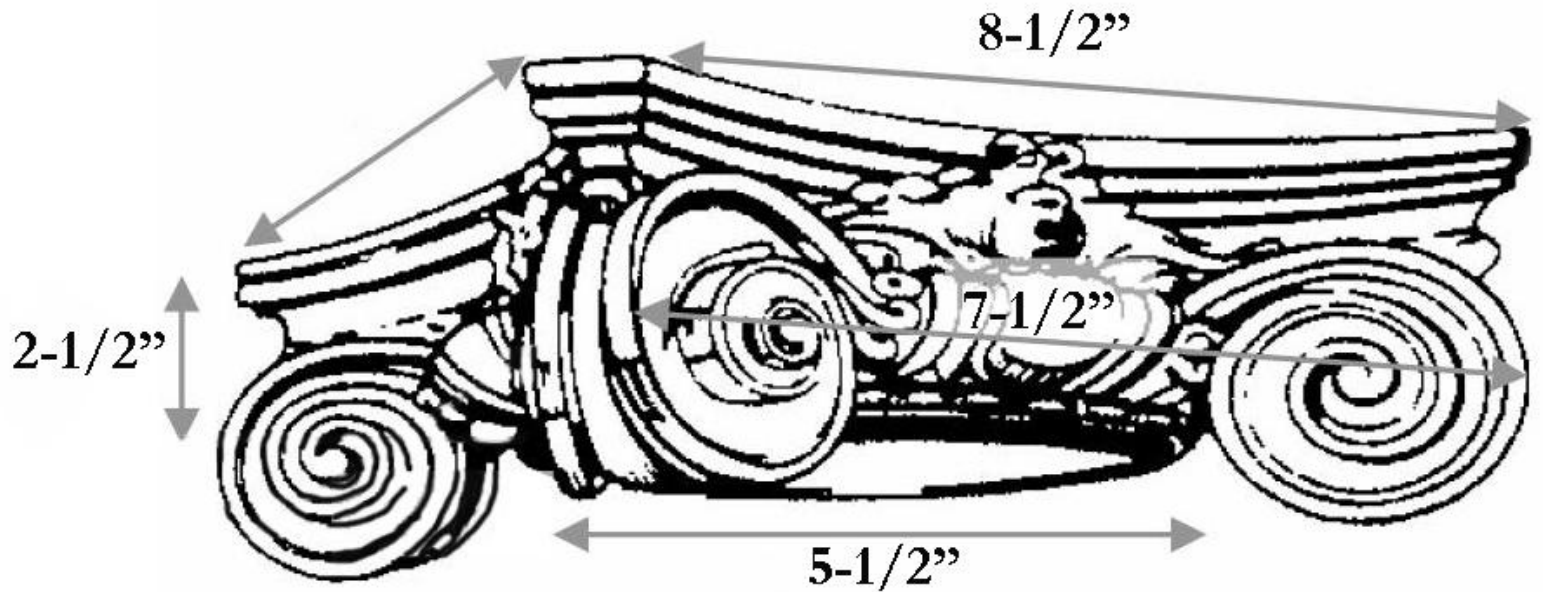

SPECIFICATIONS

Load Bearing:	Yes
Material:	Cast Polyester Resin
Base Width:	5-1/2"
Height:	2-1/2"
Abacus:	8-1/2"
Scroll to Scroll:	7-1/2"