

CHADSWORTH INCORPORATED

CAST RESIN CAPITALS

6" SCAMOZZI

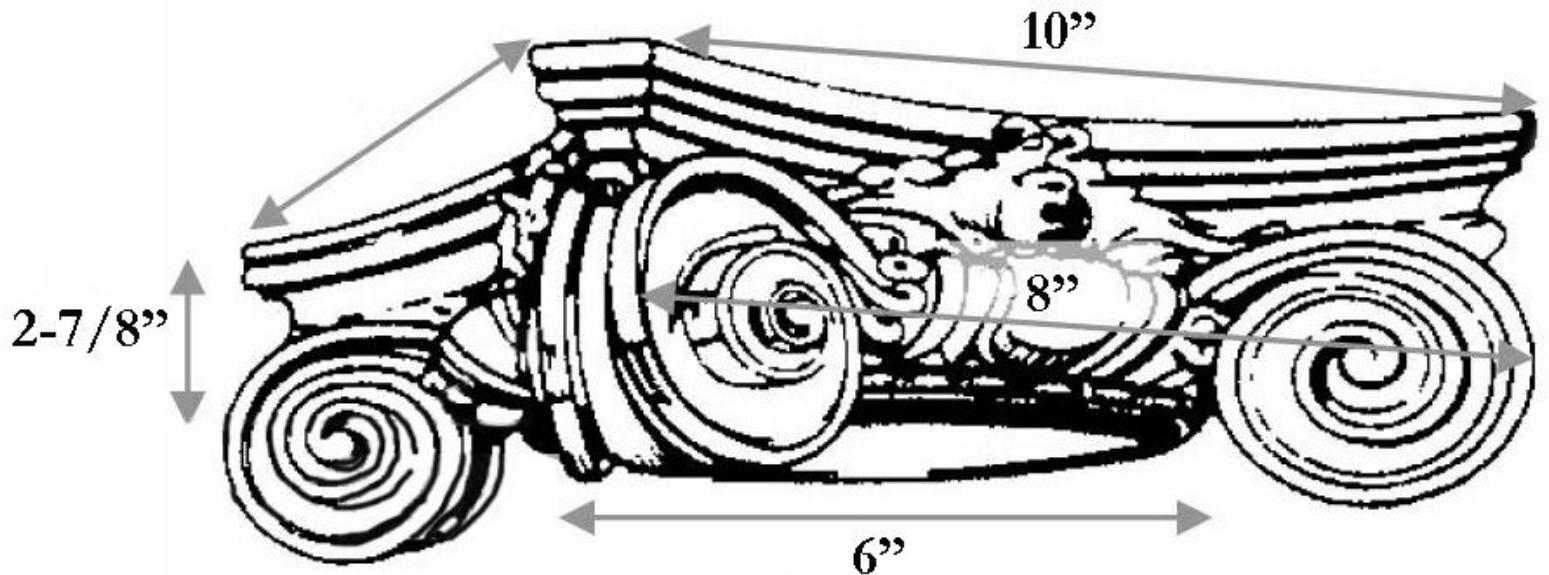

SPECIFICATIONS

Load Bearing:	Yes
Material:	Cast Polyester Resin
Base Width:	6"
Height:	2-7/8"
Abacus:	10"
Scroll to Scroll:	8"