

CHADSWORTH INCORPORATED

CAST RESIN CAPITALS

8-1/2" SCAMOZZI

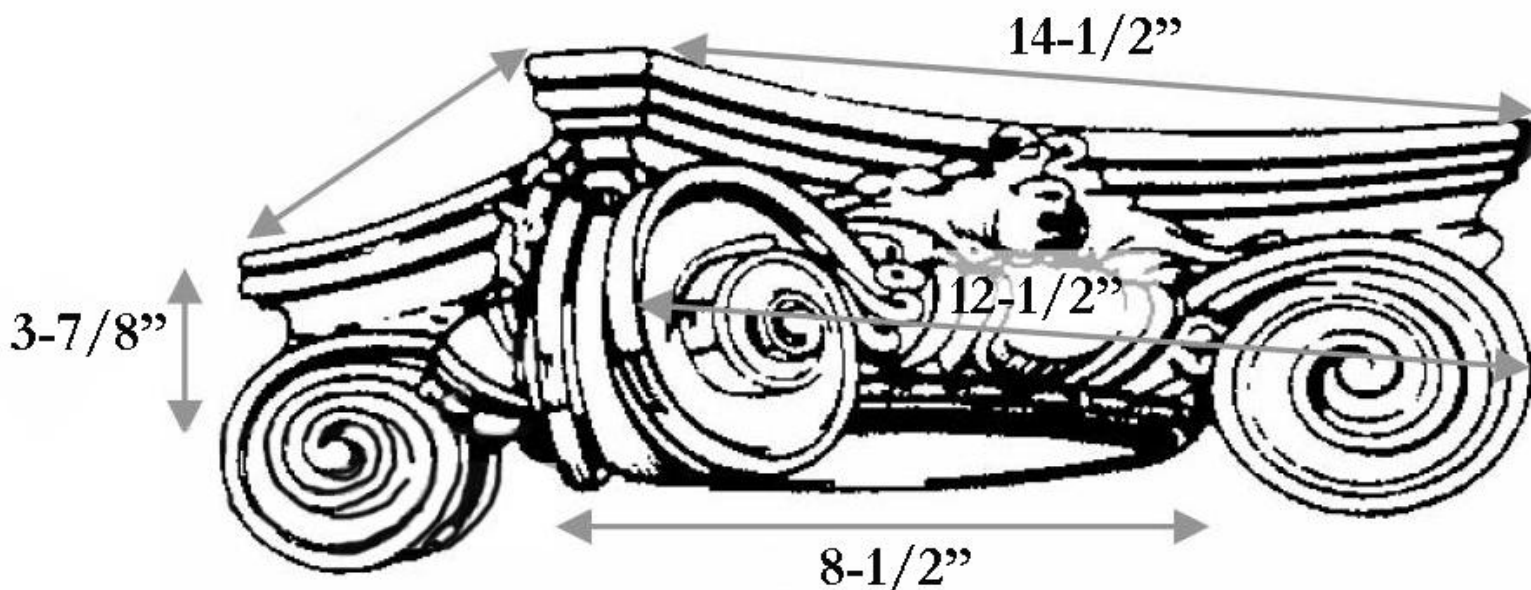

SPECIFICATIONS

Load Bearing:	Yes
Material:	Cast Polyester Resin
Base Width:	8-1/2"
Height:	3-7/8"
Abacus:	14-1/2"
Scroll to Scroll:	12-1/2"