

CHADSWORTH INCORPORATED

POLYURETHANE GREEK ERECHTHEUM CAPITALS

FOR A 16" COLUMN

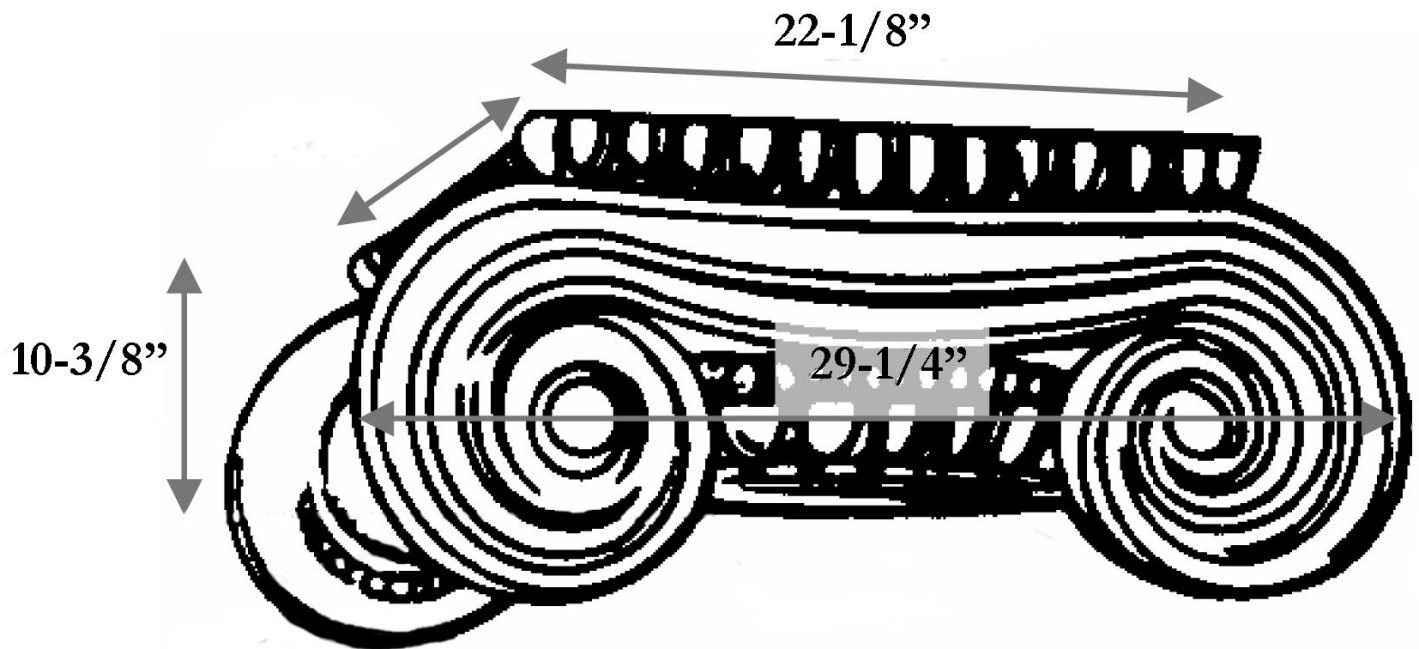

SPECIFICATIONS

Load Bearing:	No
Material:	High Quality Polyurethane
Column Size:	16"
Height:	10-3/8"
Abacus:	22-1/8"
Capital Projection:	10-1/4"
Outside to Outside:	29-1/4"