

CHADSWORTH INCORPORATED

POLYURETHANE ROMAN IONIC CAPITALS

FOR A 12" COLUMN

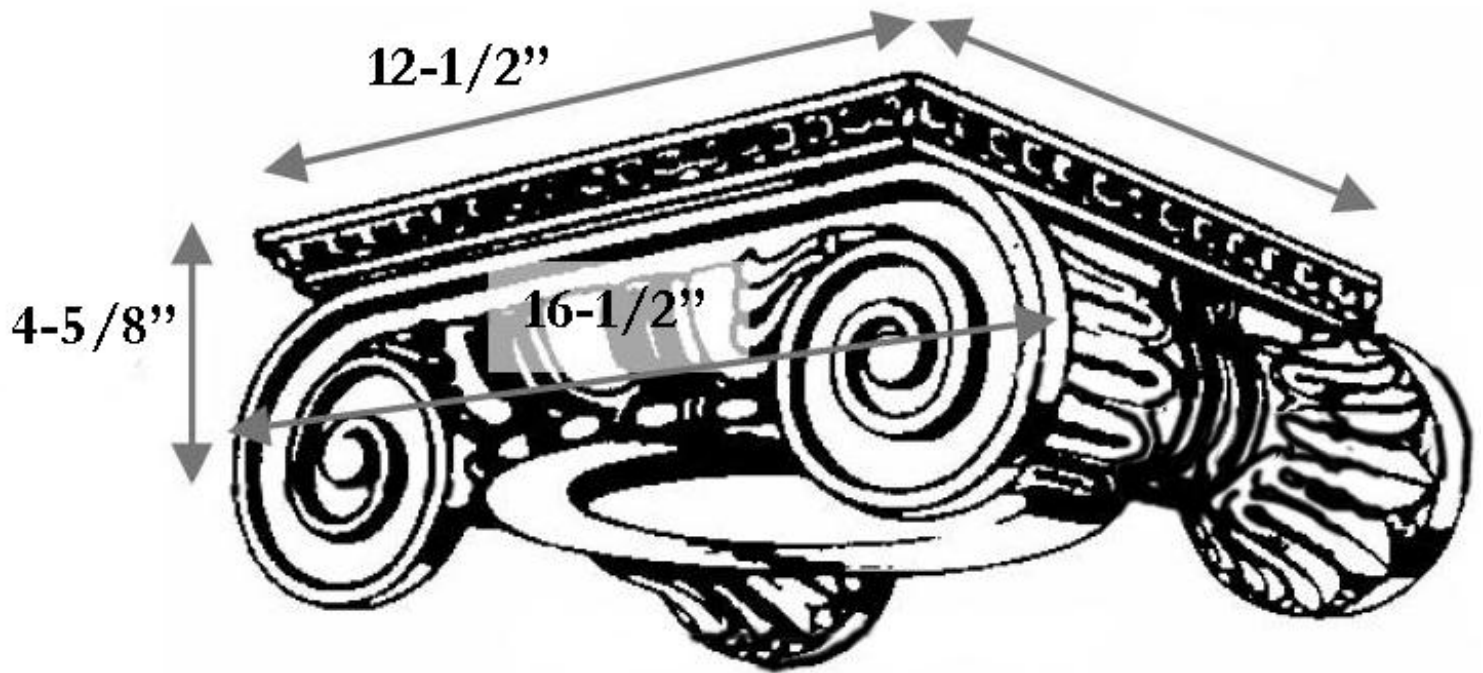

SPECIFICATIONS

Load Bearing:	No
Material:	High Quality Polyurethane
Column Size:	12"
Height:	4-5/8"
Abacus:	12-1/2"
Capital Projection:	5"
Outside to Outside:	16-1/2"

CHADSWORTH INCORPORATED • 277 NORTH FRONT STREET • HISTORIC WILMINGTON, NC 28401

PHONE: 1.800.486.2118 • FAX: 910.763.3191 • E-MAIL: sales@columns.com