

# CHADSWORTH INCORPORATED

## POLYURETHANE SCAMOZZI CAPITALS

FOR A 10" COLUMN

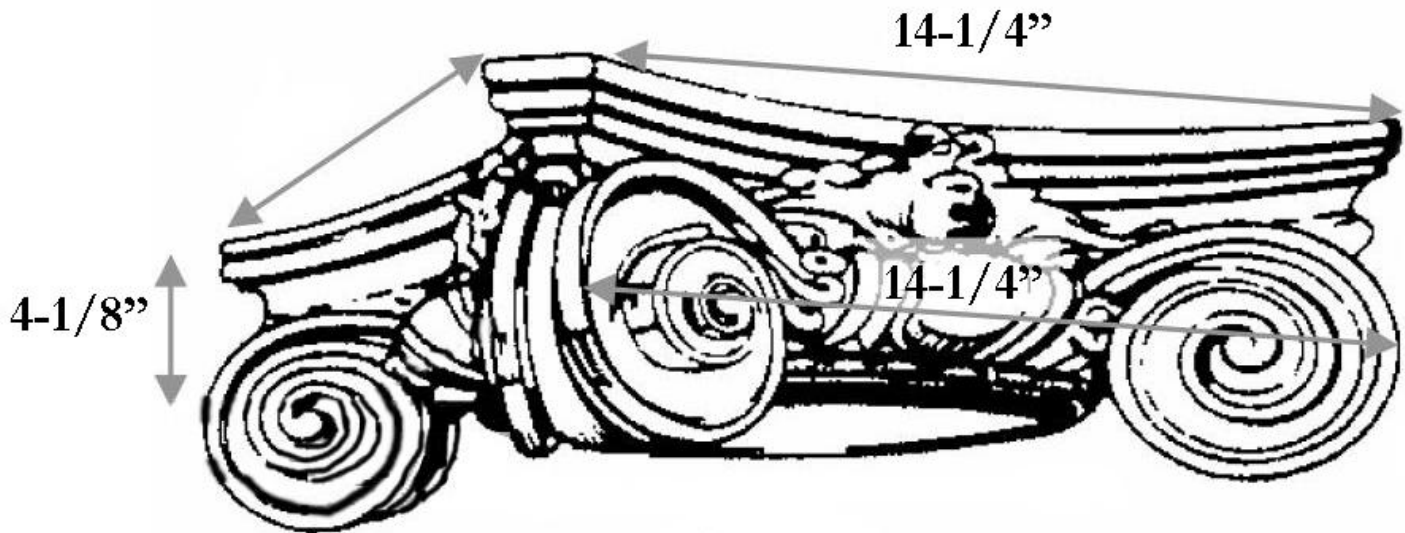

### SPECIFICATIONS

Load Bearing:	No
Material:	High Quality Polyurethane
Column Size:	10"
Height:	4-1/8"
Abacus:	14-1/4"
Capital Projection:	5-3/8"
Outside to Outside:	14-1/4"