

CHADSWORTH INCORPORATED

POLYURETHANE SCAMOZZI CAPITALS

FOR A 14" COLUMN

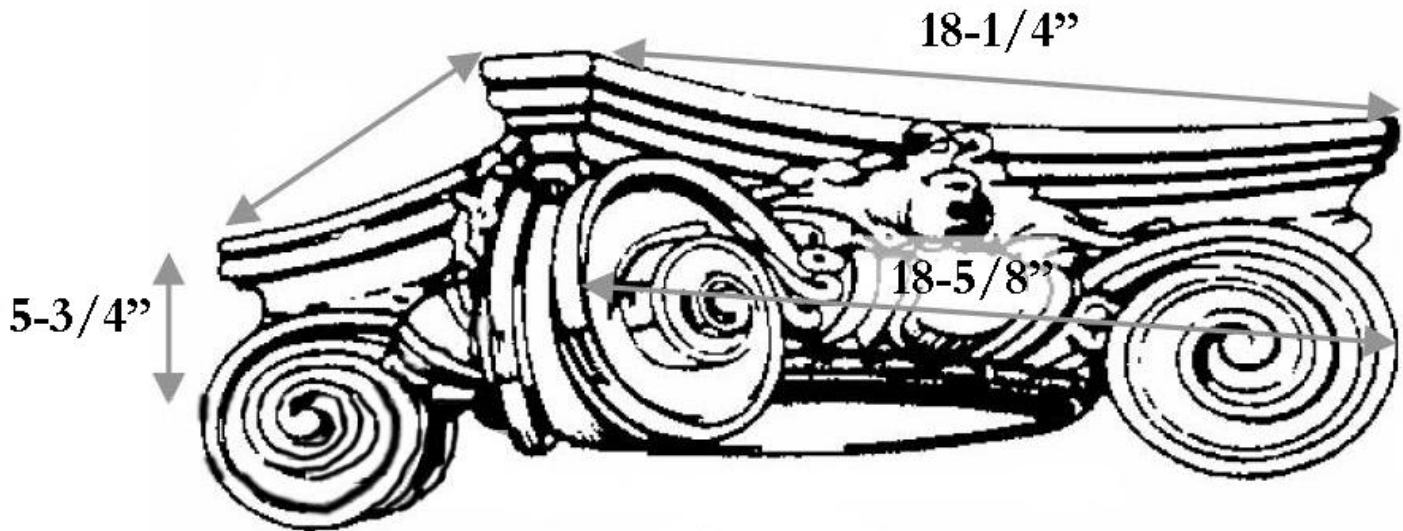

SPECIFICATIONS

Load Bearing:	No
Material:	High Quality Polyurethane
Column Size:	14"
Height:	5-3/4"
Abacus:	18-1/4"
Capital Projection:	6-5/8"
Outside to Outside:	18-5/8"