

CHADSWORTH INCORPORATED

POLYURETHANE SCAMOZZI CAPITALS

FOR A 20" COLUMN

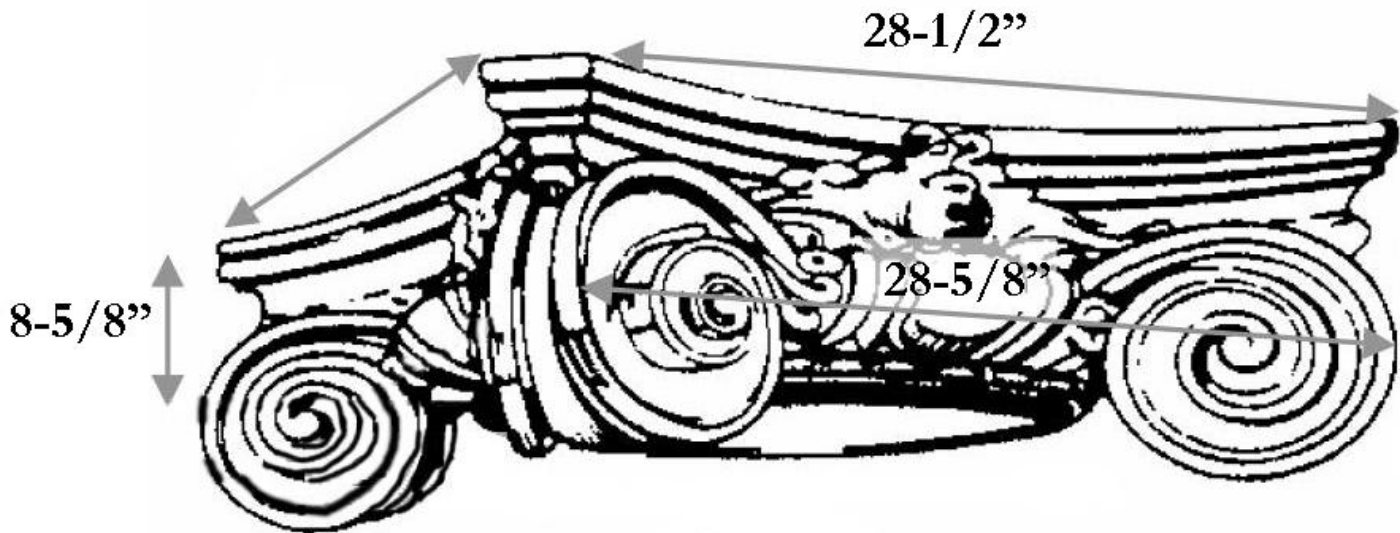

SPECIFICATIONS

Load Bearing:	No
Material:	High Quality Polyurethane
Column Size:	20"
Height:	8-5/8"
Abacus:	28-1/2"
Capital Projection:	10-1/4"
Outside to Outside:	28-5/8"