

CHADSWORTH INCORPORATED

CAST RESIN CAPITALS

11-1/2" ROMAN IONIC

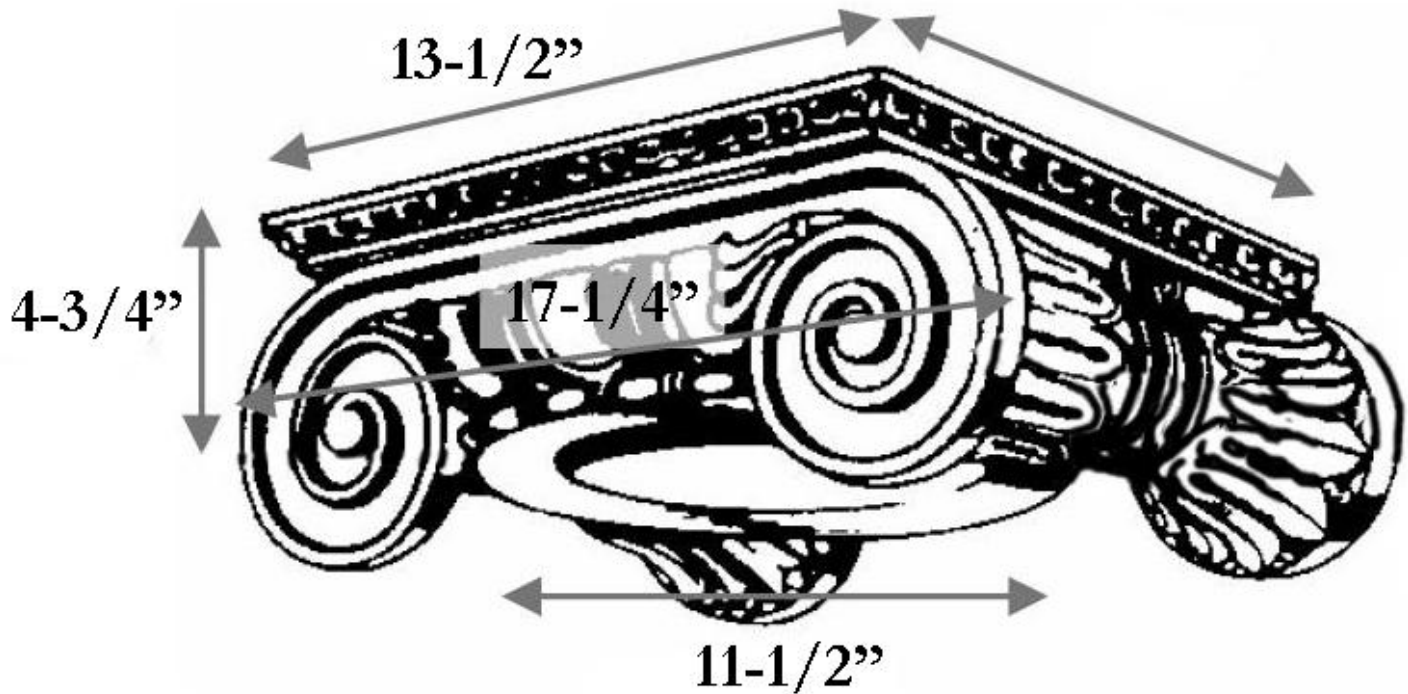

SPECIFICATIONS

Load Bearing:	Yes
Material:	Cast Polyester Resin
Base Width:	11-1/2"
Height:	4-3/4"
Abacus:	13-1/2"
Scroll to Scroll:	17-1/4"