

CHADSWORTH INCORPORATED

CAST RESIN CAPITALS

22-3/4" ROMAN IONIC

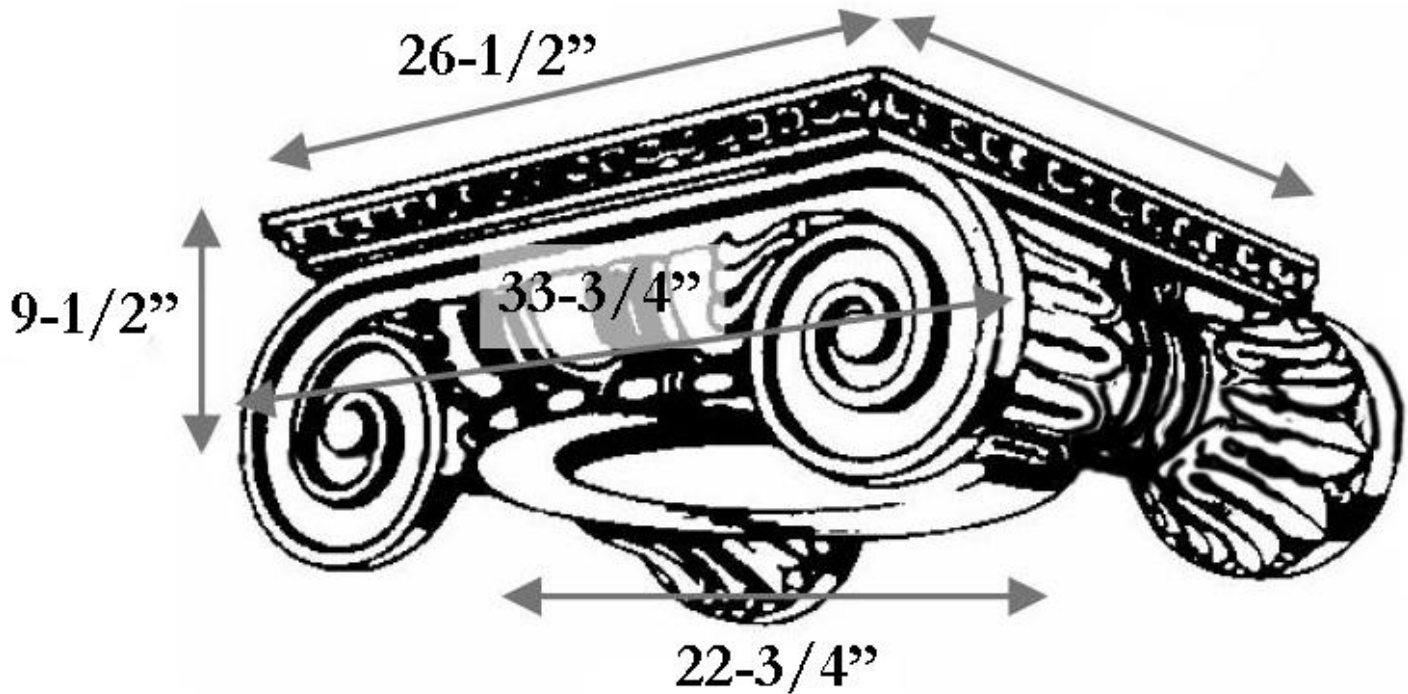

SPECIFICATIONS

Load Bearing:	Yes
Material:	Cast Polyester Resin
Base Width:	22-3/4"
Height:	9-1/2"
Abacus:	26-1/2"
Scroll to Scroll:	33-3/4"